

Installation manual

Log cabin KENTUCKY 4

Width 300 x Depth 300 cm

Log thickness 44 mm



The producer shall have the right to make technical changes to the product • Technische Änderungen vorbehalten • Le producteur réserve le droit d'effectuer des modifications techniques au produit • Il produttore mantiene il diritto di apportare modifiche tecniche al prodotto • Reservado el derecho a modificaciones técnicas • Produsent forbeholder seg retten til å endre tekniske egenskaper ved produktet • Alle rechten en technische wijzigingen voorbehouden • Výrobce si vyhrazuje právo na technické změny výrobku • Valmistaja pidättää oikeuden tehdä tuotteeseen teknisiä muutoksia • Tillverkaren har rätt att utföra tekniska förändringar för produkten

1 General information



Dear client,

We are glad that you have decided in favour of our garden house!

Please read the assembly manual carefully before proceeding with the house installation! You will thus avoid problems and will not waste time.

Recommendations:

- Keep the house package until its complete assembly in a dry place, but not in direct contact with the ground, protected from weather conditions (moisture, the sun, etc.). Do not keep the house package in a heated room!
- When selecting the garden house location, make sure that the house will not be subjected to extreme weather conditions (areas of strong snowfall or winds); otherwise you should attach the house (for instance, with anchors) to the subsoil.



Warranty

Your house is made from high quality fir and delivered in the natural (unprocessed) form. If, despite our thorough inspection, you should have complaints, please submit the filled out control sheet and purchase invoice to the product seller.

ATTENTION: Please be sure to keep the documentation accompanying the house package! The control sheet includes the control number of the house. We can only review complaints if you submit the control number of the house to the seller!

The warranty does not cover:

- Peculiarities of wood as a natural material
- Wooden details already painted (processed with a wood preservative)
- Wooden details containing whole branches that do not endanger the stability of the house
- Colour tone variations caused by wood structure differences that do not influence wood lifetime
- Wooden details containing (caused by drying) small cracks/gaps that do not pass through and do not influence the structure of the house
- Twisted wooden details if they can nevertheless be installed
- Roof and floor boards that may have on their concealed surfaces some non-planed areas, colour differences and waning
- Complaints resulting from an incompetent manner of the installation of the house or the house subsiding due to an incompetently made foundation
- Complaints caused by introducing self-initiative changes to the house, such as the deformation of wooden details and doors/windows due to an incompetent manner of wood processing; the attachment of storm braces too rigidly, doorframes being screwed onto wall logs, etc.

The complaints covered by the warranty are satisfied to the extent of replacing the deficient/faulty material. All other demands will be excluded!



Garden house painting and maintenance

Wood is a natural material, growing and adapting depending on weather conditions. Large and small cracks, colour tone differences and changes, as well as a changing structure of wood are not errors, but a result of wood growing and a peculiarity of wood as a natural material.

Unprocessed wood (except for foundation joists) becomes greyish after having been left untouched for a while, and can be turn blue and become mouldy. To protect the wooden details of your garden house, you must immediately process them with a wood preservative.

We recommend that you cover the floor boards in advance with a colourless wood impregnation agent, especially the bottom sides of the boards, to which you will no longer have access when the house is assembled. Only this will prevent moisture penetration.

We definitely recommend that you also process the doors and windows with a wood impregnation agent, and do that namely both inside and outside! Otherwise the doors and windows can become twisted.

After the house assembly is completed, we recommend for the conclusive finishing a weather protection paint that will protect wood from moisture and UV radiation.

When painting, use high quality tools and paints, follow the paint application manual and manufacturer's safety and usage instructions. Never paint a surface in strong sunlight or rainy weather. Consult a specialist regarding paints suitable for unprocessed softwood and follow the paint manufacturer's instructions.

Having been properly painted, your garden house's lifetime will increase substantially. We recommend that you inspect the house thoroughly once every six months.

2 Preparation for assembly

Tools and preparation of components

To assemble the garden house, you will need the following tools:



assembly aid



ladder



hammer

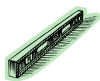

water-level



screwdriver



saw



knife



measuring tape



pliers



drill

ADVICE: To avoid splinters, we recommend that you wear the corresponding protective gloves during the assembly process.

Installation manual

Preparation of components:

Sort the components based on the wall plans (see Technical specifications) and place them at the four sides of the house in the installation sequence.

ATTENTION: Never place the components directly on grass or a muddy surface because it will be very difficult or even impossible to clean them up later!

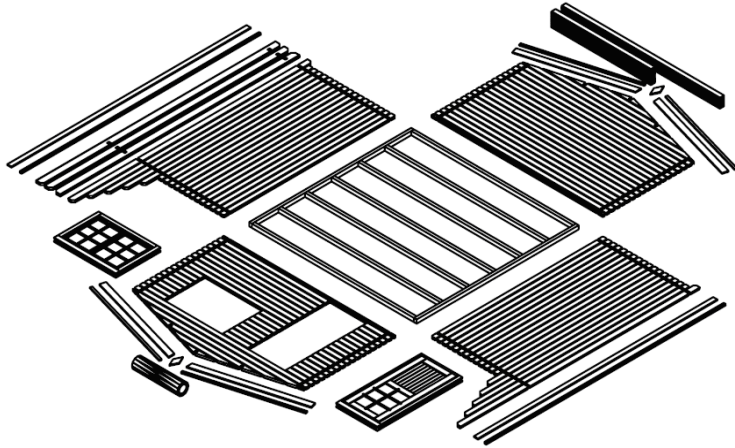

Foundation

A good foundation is the most important aspect guaranteeing the duration and safety of your house. Only a completely level and bearing foundation will ensure problem-free installation of the house, its stability and especially the matching of the doors. With a good foundation, your house will stand for many years more.

Prepare the foundation so that its upper edge extends from the ground to a height of at least 5 cm. At the same time make sure that there are sufficient air apertures under the house floor for ventilation.

We recommend the following foundation options:

- Strip or spot foundation
- Foundation from concrete or pavement slabs
- Cast concrete bed

Prepare the foundation so that the foundation joists are propped up on every side with intervals not exceeding 50-60 cm.

Consult an expert in this field or have the foundation prepared by specialists.

3 Garden house assembly

ATTENTION:

- You will find included in the house package one spare log (longest wall log).
- You will find included in the house package one spare board (longest roof or floor board).
- The house package also includes 2-3 marked hitting blocks (wall profile approximately 20-30 cm long).

All of the details listed above ARE NOT mentioned in the specification list.

- The drawings have the details marked with three-digit position numbers. The exact positions of those details that have the third digit "x" can be found in the specification list.

Installation manual

Base frame (Foundation joists)

The base frame of the house must be completely flat and level to ensure that the installation proceeds without problems.

ATTENTION: different house can have different foundation placements – see the appended base frame drawing (in Technical specifications)!

Place the impregnated foundation joists on the prepared foundation in accordance with the drawing at equal intervals. Make sure that the joists are level and prior to screwing them together.

ADVICE: It is recommended to place between the foundation joists and foundation a damp-proof course that will protect the house from moisture and decay.

ADVICE: To ensure protection from wind and storm, it is recommended to attach the foundation joists to the foundation (for this, you can use for instance metal angles, anchors, etc.). The corresponding materials are not included in the supplied kit!

Installation of foundation joists:

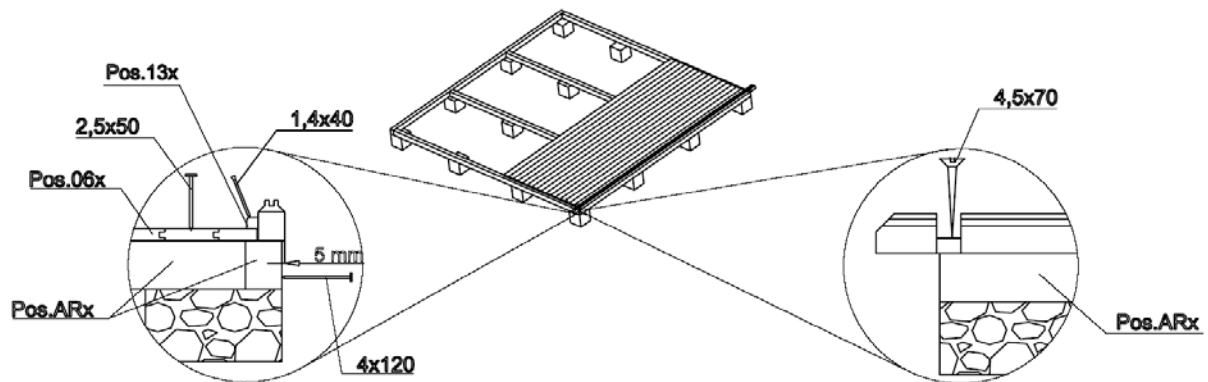

Floor

Install the floor right after foundation bearers have been placed into position and screwed together. Cover the floor for the assembling time thus avoiding unnecessary smudging on the floor.

Start assembling the floor as shown on the drawing moving in both directions. If necessary, cut the last boards of the sides to suitable width.

When placing floor boards, please note that the boundary line of floor boards must be all around the floor 27 mm inside from external edge of foundation bearers. It will guarantee that the first layer of wall logs will fit on the base frame.

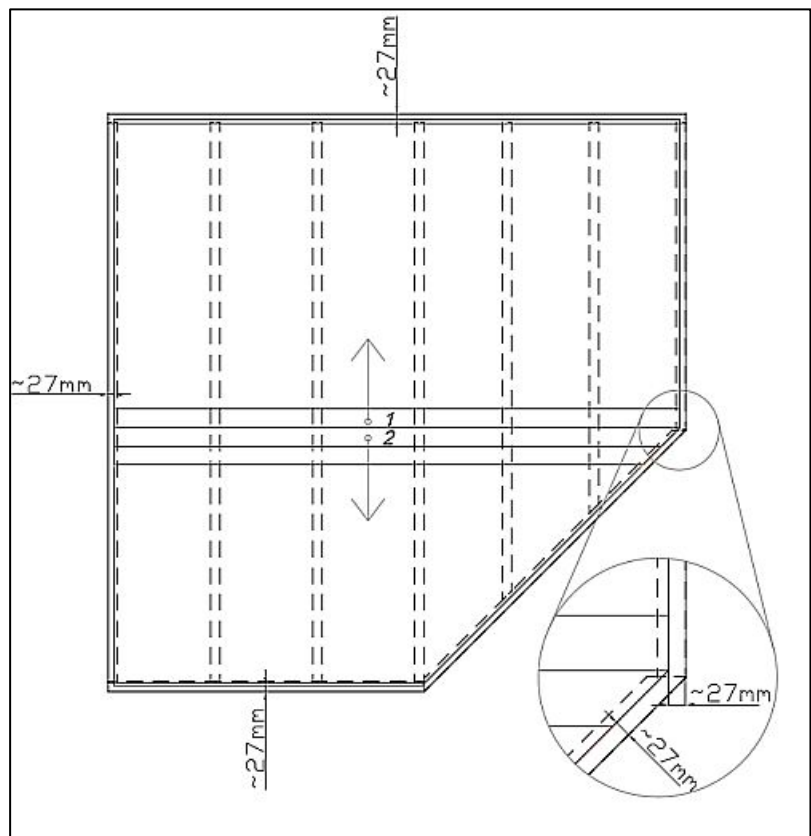

Installation manual

Floor boards should be fixed to every foundation bearer with nails 2,5x50 mm. For nicer finish we suggest to nail the boards from top part of the tongue so the head of the nail will be covered with groove of next board.

The final operation is the fitting of the floor beadings to cover the spaces between the floor boards and walls. If necessary, cut the floor beadings to the suitable length.

ATTENTION: Depending on the climate at the house location, the floor boards can either swell or diminish. If the floor boards are very dry while the climate is damp, they will easily absorb moisture. In this case, the floor boards should not be attached very densely to avoid likely bulging. Leave some space (1-2 mm) between the floor boards to allow for swelling. But if your climate is warm and dry, you can install the boards densely because they will become drier and spaces may appear between them.

Walls

When installing the walls, it is important to remember that:

- The logs are always assembled with their tongue upwards!
- If necessary, use the hitting block and hammer! Never directly hit the tongue with the hammer!

Install the walls in accordance with the appended wall plans (see Technical specifications).

First of all place half logs of front and back wall at the correct location and attach them with screws to the foundation joists. Then install the side wall logs. Make sure that the first layer of logs extends a bit over the foundation joists: the logs must extend over the joists by some 3-5 mm. You will thus protect the house from moisture, allowing the free flow of rainwater into the ground.

ATTENTION: After the first layer of logs, measure the diagonal lengths and, if necessary, re-install the logs. Only if the diagonal lengths are completely equal is the base frame rectangular and you can mutually attach the logs.

The first layer of logs:

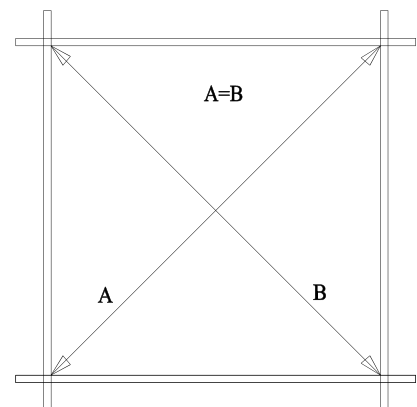

Continue the installation of the walls by strongly forcing the wall logs into one another. If necessary, use the hitting block and hammer. At the same time, do not forget to begin the installation of the door and windows. You should definitely begin the door installation after the 5th-6th layer of logs.

Door and window

Doorframe:

- If it is a double door, the doorframe is supplied in separate parts due to transportation requirements and you will have to begin by assembling it.
- To do this, place together the 4 parts of the frame and screw them onto one another.
- Make sure that the part of the frame with the deeper notch is installed upwards. The lateral jamb parts have hinges and are mirrored.
- It is recommended to install the leaves later.
- If it is a single door, its frame and leaf are supplied already assembled.

Doorframe installation (Only necessary for a double door!):

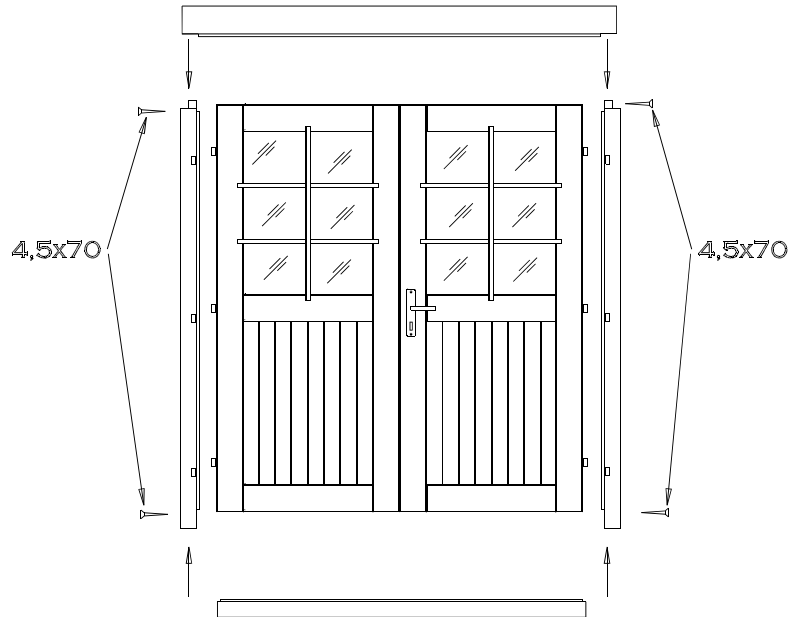

Door installation:

The doorframe is placed at the formed aperture and pushed with force onto the lower log. If it is a double door, place the leaves on the hinges now. To open and close the door, fit the separately packaged lock and handle.

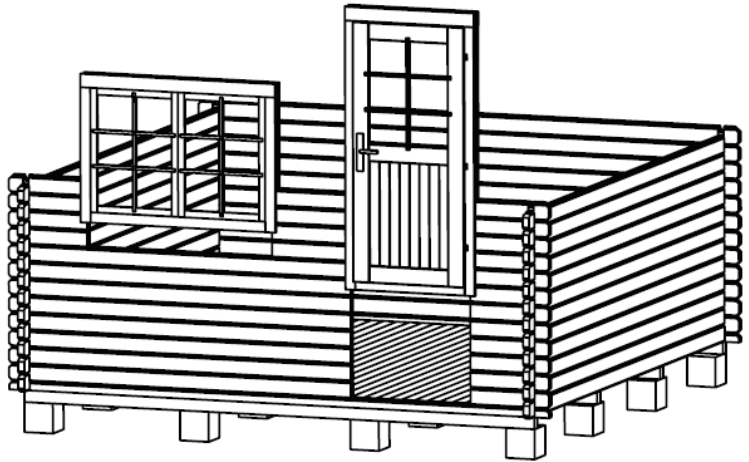

Window installation:

Continue with the installation of the wall logs until you reach the window height. The wall plans (see Technical specifications) show how many logs go under the window. Install the window similarly with the door. Just like the door, push the window frame with the window into the window aperture onto the lower log, applying force. Make sure that the window is not fitted backwards (topsy-turvy).

ADVICE: Definitely make sure that the windows and doors open in the proper direction. The doors always open from the inside **to the outside**. The revolving-tilting windows open **to the inside**. The revolving and the slinging windows open **to the outside** (the window handles are on the inside).

ATTENTION: It is not necessary to fix the doors and windows to the wall logs! If you wish to do this, it will be sufficient to fix them with a couple of screws in the lower part of the frame because as they dry, the wall logs will begin subsiding.

You can conduct the final adjustments of the doors and windows only some 2-3 weeks after the house installation, when the house will have become adapted to weather conditions and its logs settled.

Installation manual

Roof

Before installing the roof, make sure that the house is completely level. Use the water-level to check all walls.

ATTENTION: When placing the roof, use a stable ladder. Do not step on the roof as the structure is suitable to sustain only an even load (snow, wind, etc.), and not a point load!

Install the purlins PR1 on the walls so that the notches will cover the corners of the walls. Fixate the purlins to the central fixing block (Pos. 153) and on the walls. Now place the pos. PR2 and PR3 from the top to the purlin and from the bottom to the upper wall log. Fixate the U-Profile boards between the purlins and on the walls.

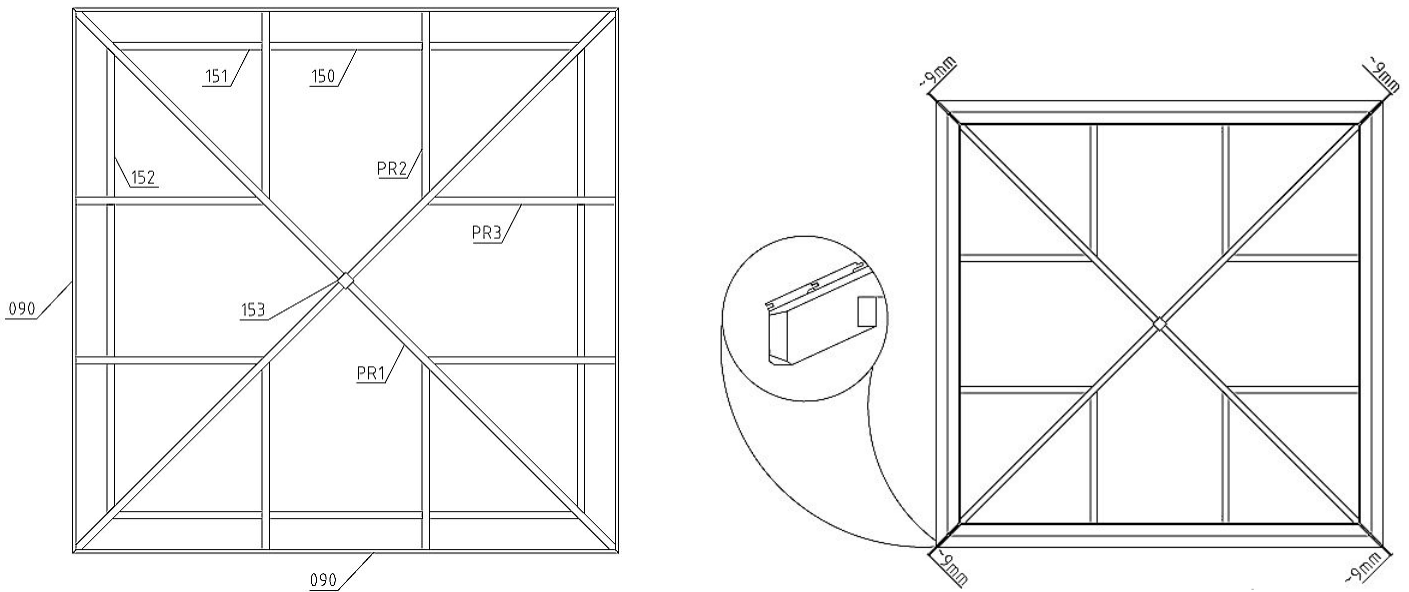

Start placing the roof boards with the longest board from the bottom. Put the groove side downwards that the bottom side of the board will meet the ends of the rafters. It is recommended to place the roof boards in turns on the all sides of the roof. 3-5 roof boards in one turn. Fixate the roof boards on the rafters with 2,5x50 mm nails.

After you have installed the roof boards, cover it with roof covering material (not included in house kit). It is necessary to avoid the bulging of the roof boards due to wetness.

Installation manual

Storm braces (NB! Not included in some house option kits!)

Attach the storm braces (if included in the supplied kit) to the inner sides of the front (2 units) and back (2 units) walls with the supplied bolts. It is important for the logs to be drilled through in advance. Please keep the distances indicated in the drawing so that no problems occur due to wood swelling or diminishing.

ADVICE: Make sure that the storm braces are attached to the apex log from above and to the middle of the first full-length wall log from below. If necessary, shorten the upper ends of the slats.

Do not turn the screws tightly so wood can further swell or diminish.

With the house having settled, you should adjust the attachments so the wall logs can settle.

Installation of storm braces:

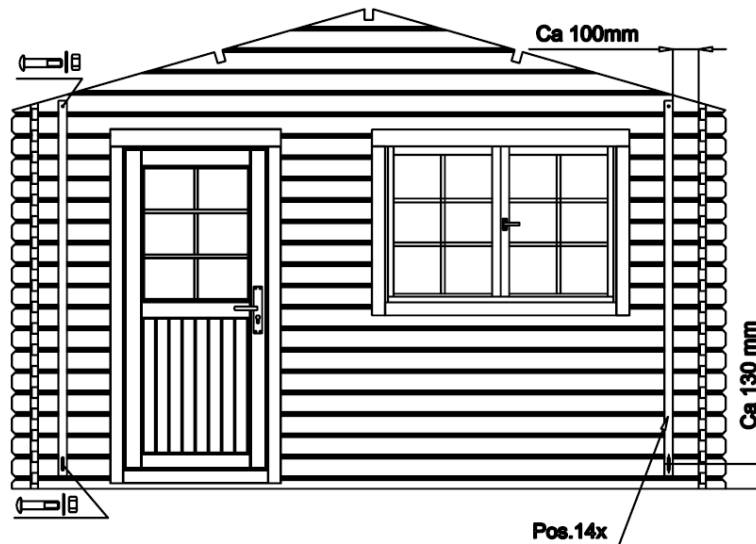

General advice:

Problem: *Gaps appear between the wall logs*

Cause: Additional details are attached to the house that do not allow wood to swell/diminish.

Solutions: If the door/window is attached to the wall logs with screws/nails, remove these screws/nails;
If the storm brace is screwed on too tightly, loosen its attachment;
If (rain water) pipes are installed on the wall, loosen their attachments;

Problem: *The doors and windows become stuck.*

Cause: The house/foundation has settled.

Solution: Check whether the house is level. Level the foundation joists and walls.

Cause: The doors and windows have swelled due to moisture.

Solution: Adjust the door and window hinges; if necessary, plane the door or window narrower.





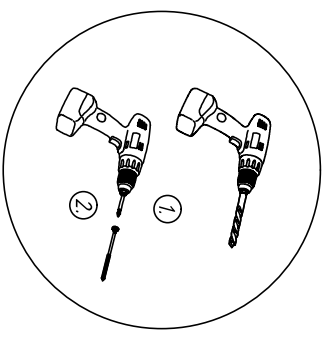
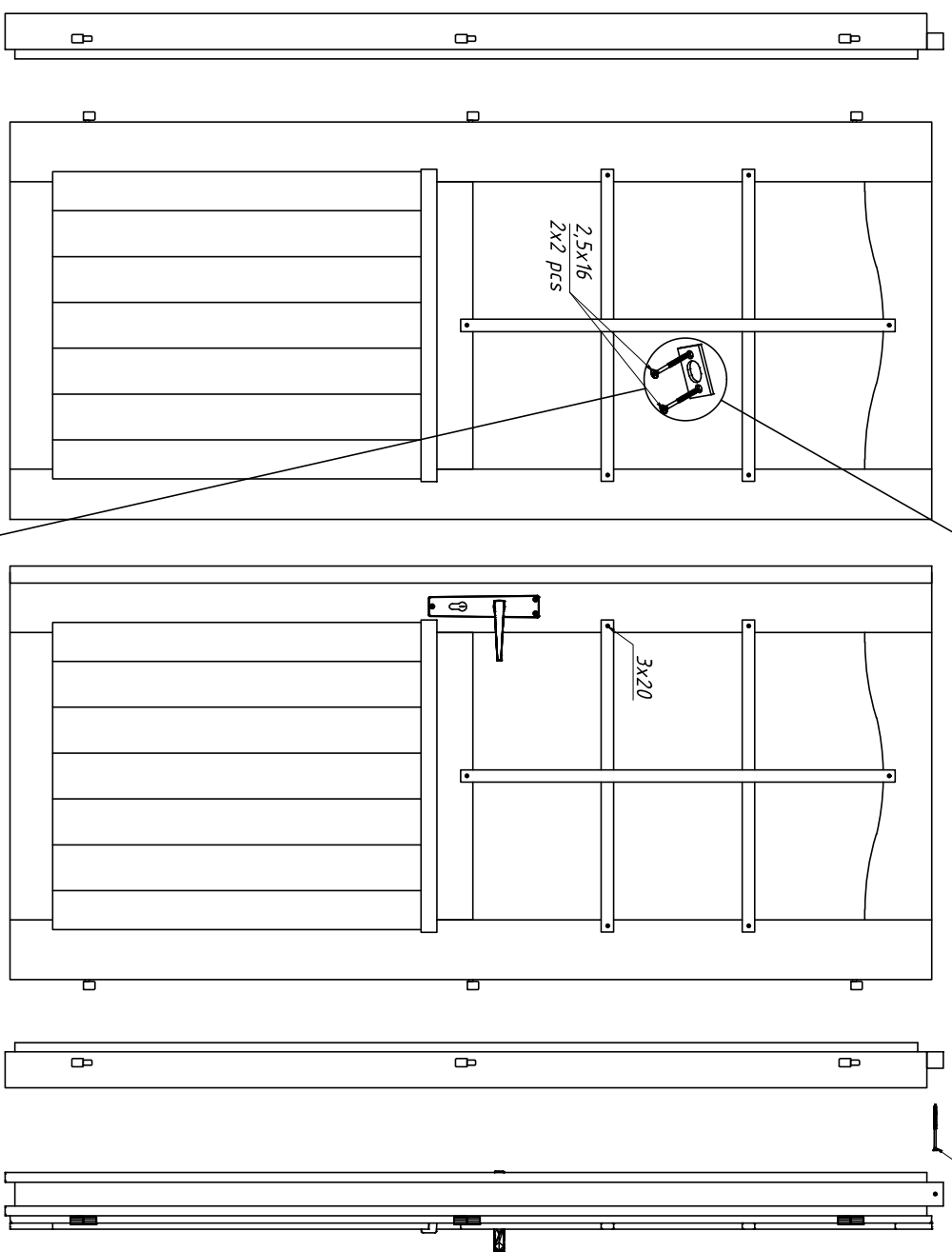
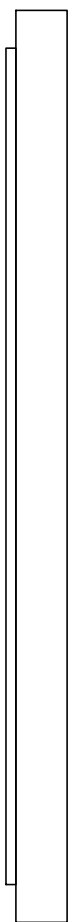
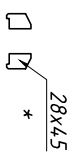
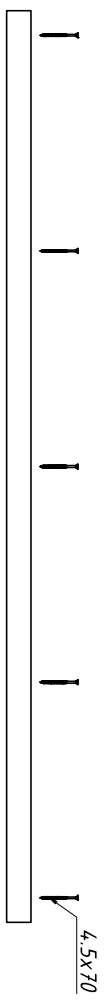



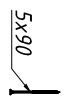

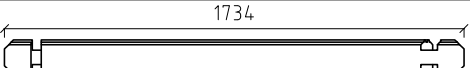

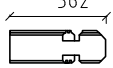
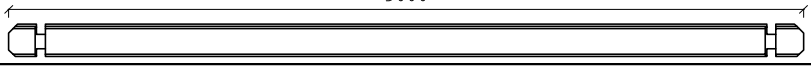
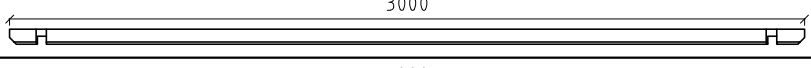

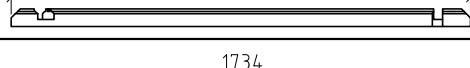
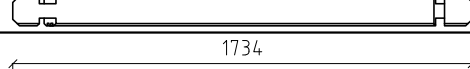
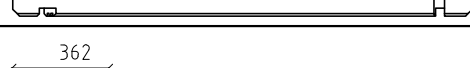

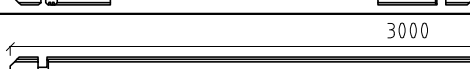

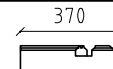
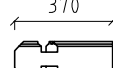
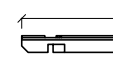
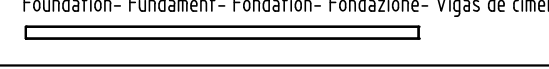

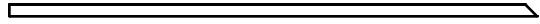



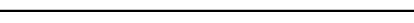
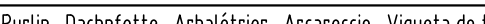

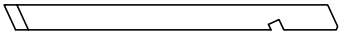
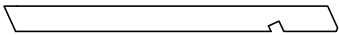

We wish you total success with the garden house installation and much joy with this house for many years to come!

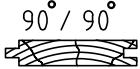

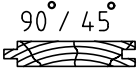



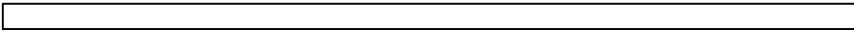
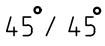

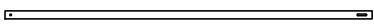
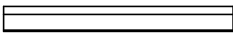

* The specification may vary depending on the specific model
 * Die Spezifikation können je nach Modell unterschiedlich sein
 * Les spécifications peuvent varier selon le modèle spécifique
 * Dependiendo del modelo, la especificación puede cambiar
 * Le specifiche possono variare a seconda del modello

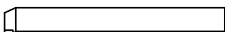

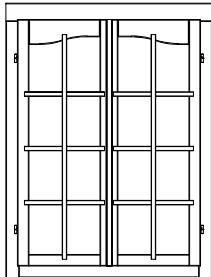
Pos	SPECIFICATION-STÜCKLISTE-NOMENCLATURE-ELEMENTI-ESPECIFICACIÓN PAJ44-3030	Pcs	Profile (mm)	Length (mm)		
001		6	44x114	1734		
002		23	44x114	362		
003		12	44x114	362		
004		37	44x114	3000		
005		2	44x55	3000		
006	 Without tonque	2	44x114	3000		
007		1	44x55	3000		
008		1	44x55	1734		
009		4	44x114	1734		
010		1	44x114	1734		
011		11	44x114	362		
012		1	44x114	1734		
013		1	44x114	3000		
014		1	44x57	370		
015		17	44x114	370		
016		17	44x114	370		
017		1	44x114	1990		
AR 1	Foundation- Fundament- Fondation- Fondazione- Vigas de cimentación 					
			90° / 90°	1	45x70	1457
AR 2	Foundation- Fundament- Fondation- Fondazione- Vigas de cimentación 					
			90° / 45°	1	45x70	1849
AR 3	Foundation- Fundament- Fondation- Fondazione- Vigas de cimentación 					
			90° / 45°	1	45x70	2270
AR 4	Foundation- Fundament- Fondation- Fondazione- Vigas de cimentación 					
			90° / 90°	4	45x70	2650
AR 5	Foundation- Fundament- Fondation- Fondazione- Vigas de cimentación 					
			90° / 90°	1	45x70	2790
AR 6	Foundation- Fundament- Fondation- Fondazione- Vigas de cimentación 					
			90° / 90°	1	45x70	1527
AR 7	Foundation- Fundament- Fondation- Fondazione- Vigas de cimentación 					
			45° / 45°	1	45x70	1786
PR 1	Purlin- Dachpfette- Arbalétrier- Arcareccio- Vigueta de tejado 					
				4	44x95	2350

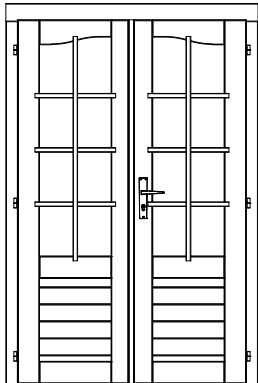
Pos	SPECIFICATION-STÜCKLISTE-NOMENCLATURE-ELEMENTI-ESPECIFICACIÓN PAJ44-3030	Pcs	Profile (mm)	Length (mm)
PR 2	Purlin- Dachpfette- Arbalétrier- Arcareccio- Vigueta de tejado 	4	44x95	1258
PR 3	Purlin- Dachpfette- Arbalétrier- Arcareccio- Vigueta de tejado 	4	44x95	1258
060	Floor board - Fussbodenbrett - Madrier du plancher - Tavola pavimento - Tabla de suelo   90° / 90°	17	19x89	2705
061	Floor board - Fussbodenbrett - Madrier du plancher - Tavola pavimento - Tabla de suelo   90° / 45°	1	19x89	2705
		1	19x89	2616
		1	19x89	2527
		1	19x89	2438
		1	19x89	2349
		1	19x89	2260
		1	19x89	2171
		1	19x89	2082
		1	19x89	1993
		1	19x89	1904
		1	19x89	1815
070	Roof board - Dachbrett - Madrier du toit - Tavola tetto - Tabla de tejado   47,74°	4	16x89	3170
		4	16x89	3008
		4	16x89	2847
		4	16x89	2684
		4	16x89	2523
		4	16x89	2361
		4	16x89	2200
		4	16x89	2035
		4	16x89	1876
		4	16x89	1714
		4	16x89	1552
		4	16x89	1390
		4	16x89	1229
		4	16x89	1067
		4	16x89	906
		4	16x89	743
		4	16x89	582
4	16x89	420		
4	16x89	258		
4	16x89	97		
Qkoonus4	Roof cap- Dachkappe- Finition métallique- Finitura di tetto- Caballete de tejado 	1		
153	Central fixing block- Dachspitzenbefestigungsholz- Bloc de fixation au sommet de toit Bloque fijador de tejado 	1	70x70	150
090	Eave edging - Dachrandbrett - Madrier en bordure du toit - Tavola bordo tetto - Tabla de valadizo   45° / 45°	4	19x95	3220
130	Floor beading - Fussbodenleiste - Baguette du plancher - Listello pavimento - Listón de suelo 	5	19x19	2712
160	Roof element- Dachelement - Panneau de toit- Elemento di tetto- Elemento de tejado  h=57	1	1232x1232	1743

Pos	SPECIFICATION-STÜCKLISTE-NOMENCLATURE-ELEMENTI-ESPECIFICACIÓN PAJ44-3030	Pcs	Profile (mm)	Length (mm)
140	Storm brace - Sturmleiste - Protection contre le vent - Antivento - Protector contra tormentas 	5	25x45	2200
150	U-profile board- U-Profilleiste- Baguette profilée en U- Listello profilo ad U- Listón de perfil U 	4	70x98	900
151	U-profile board- U-Profilleiste- Baguette profilée en U- Listello profilo ad U- Listón de perfil U 	4	70x98	862
152	U-profile board- U-Profilleiste- Baguette profilée en U- Listello profilo ad U- Listón de perfil U 	4	70x98	862
165	Slat- Leiste- Baguette- Listello- Listón 	1	19x19	1440
TA44 -29R	Window - Fenster - Fenetre - Finestra-Ventana 1003x1336   903x1236mm	2		
TU44 -29R	Door - Tür - Porte - Porta-Puerta 1244x1936   1144x1867mm	1		
QTihe ndTPE 8mm-1	Seal- Gummidichtung- Joint d'isolation- Guarnizione- Burlete 	3		5000

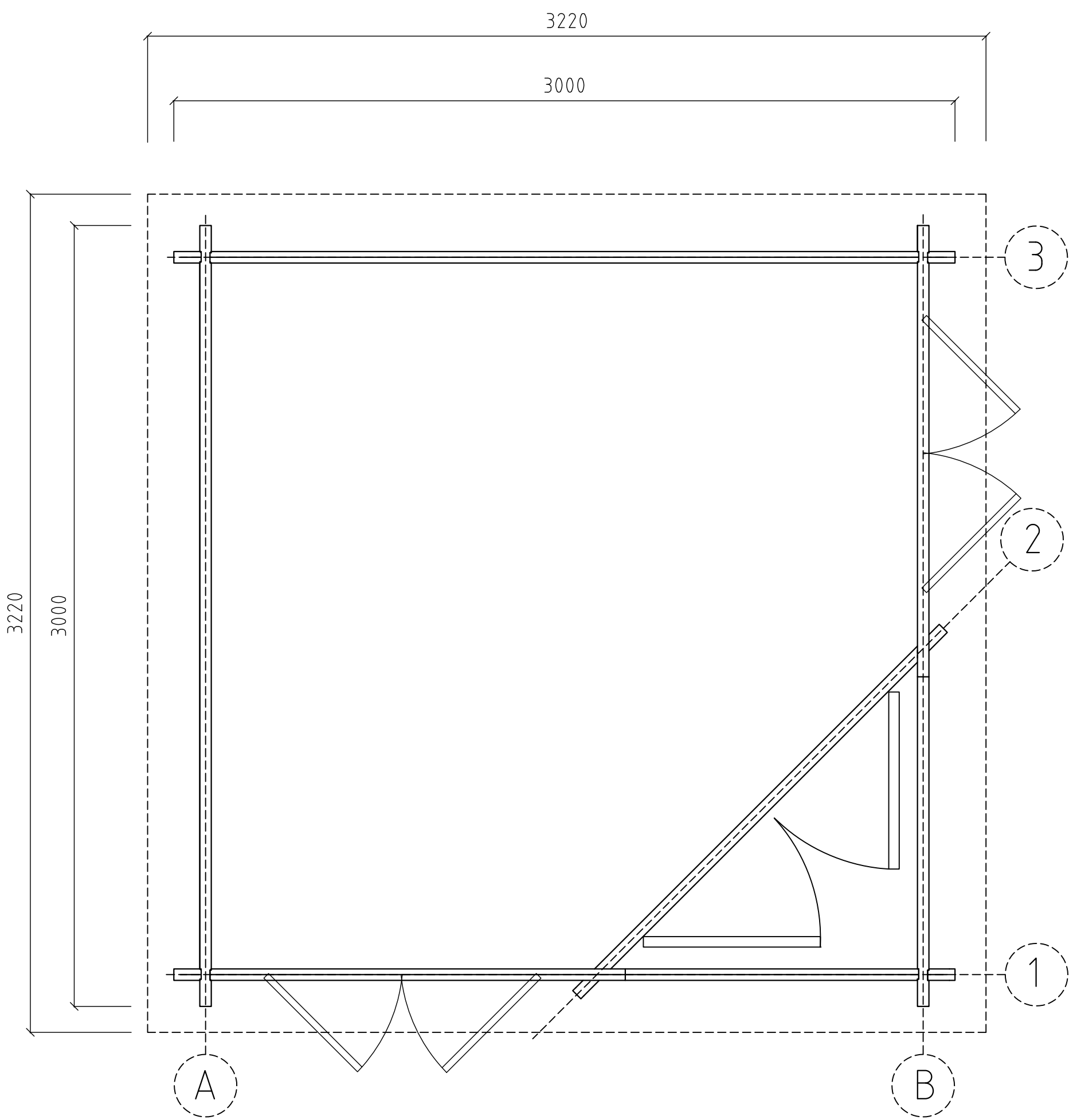

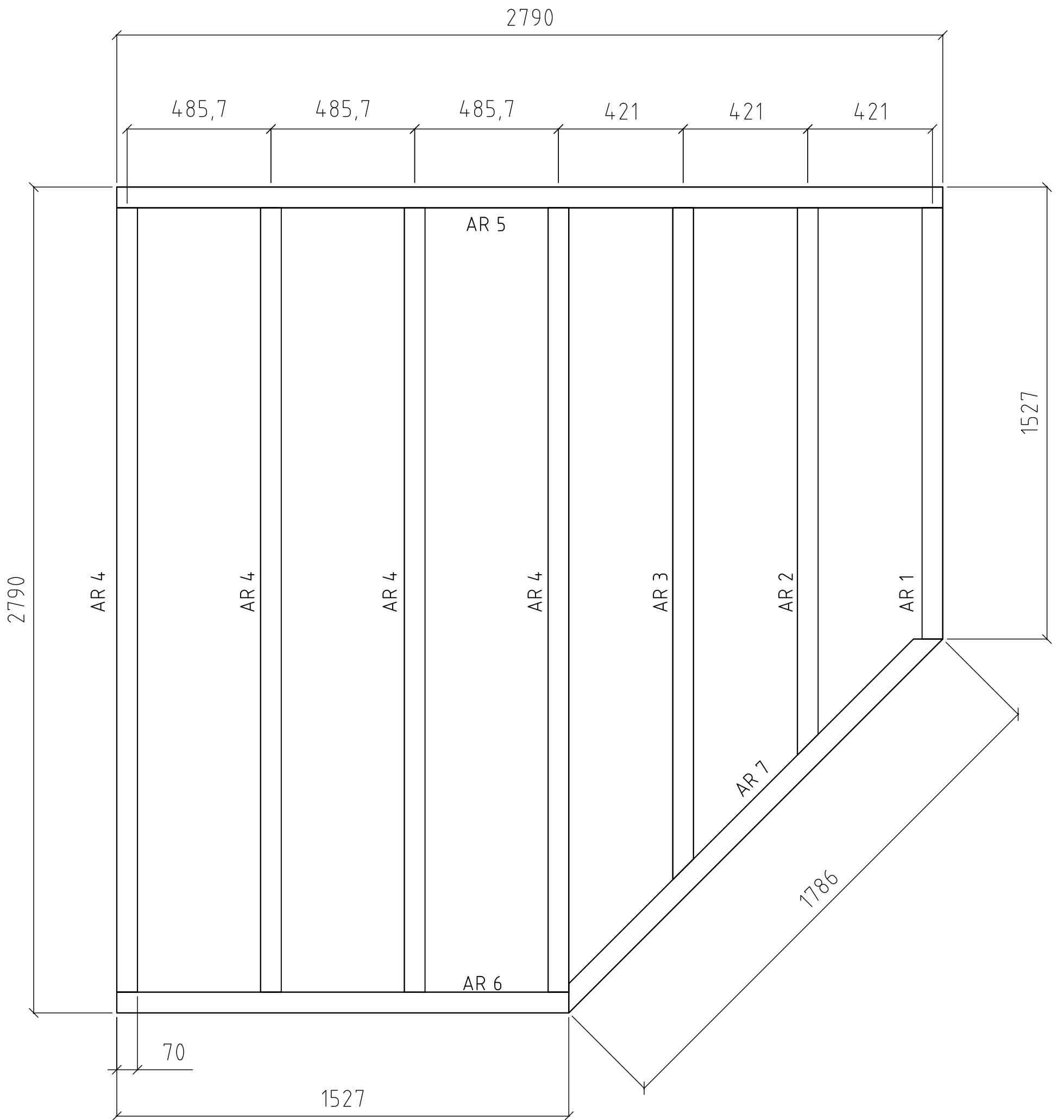

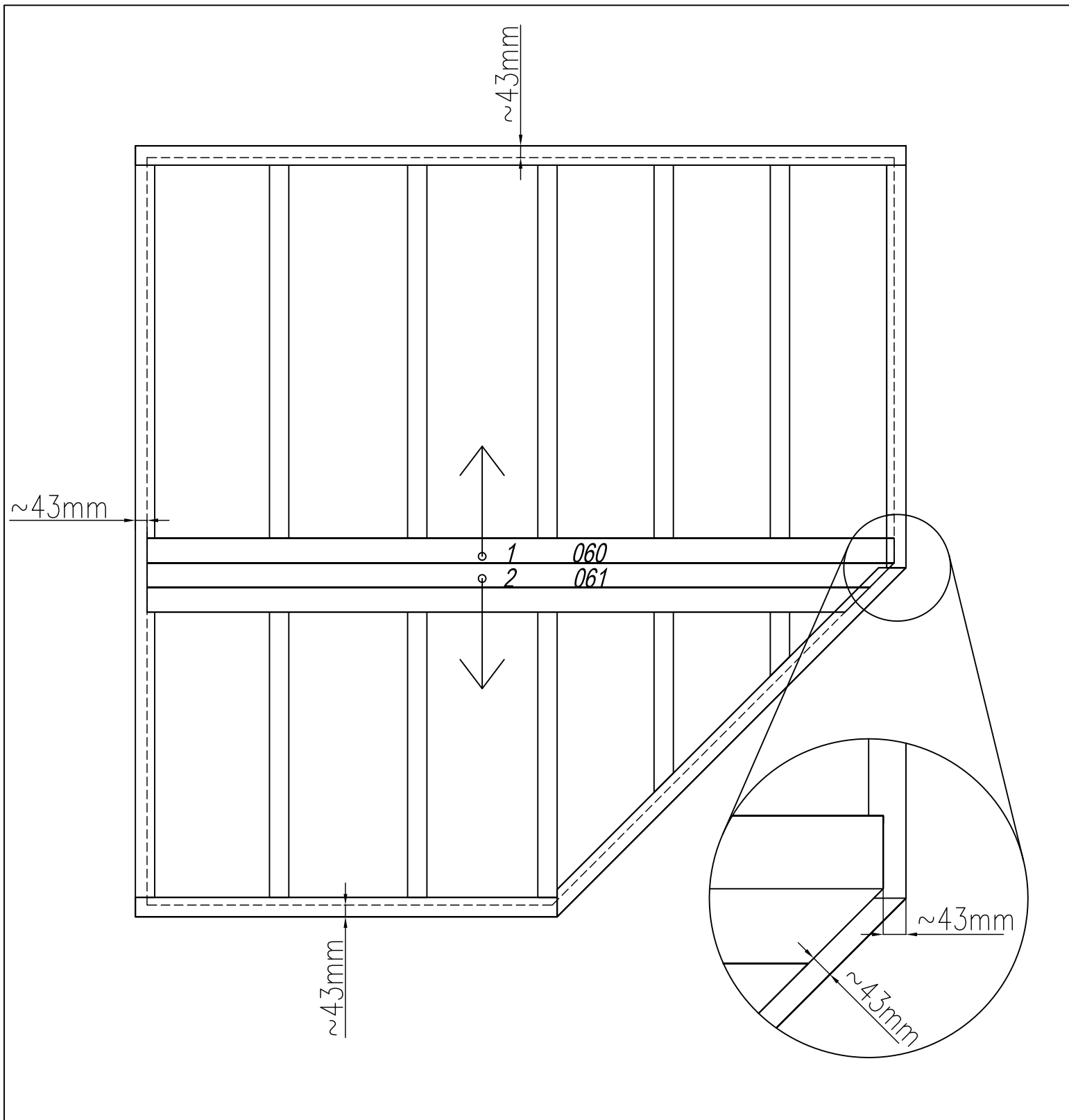

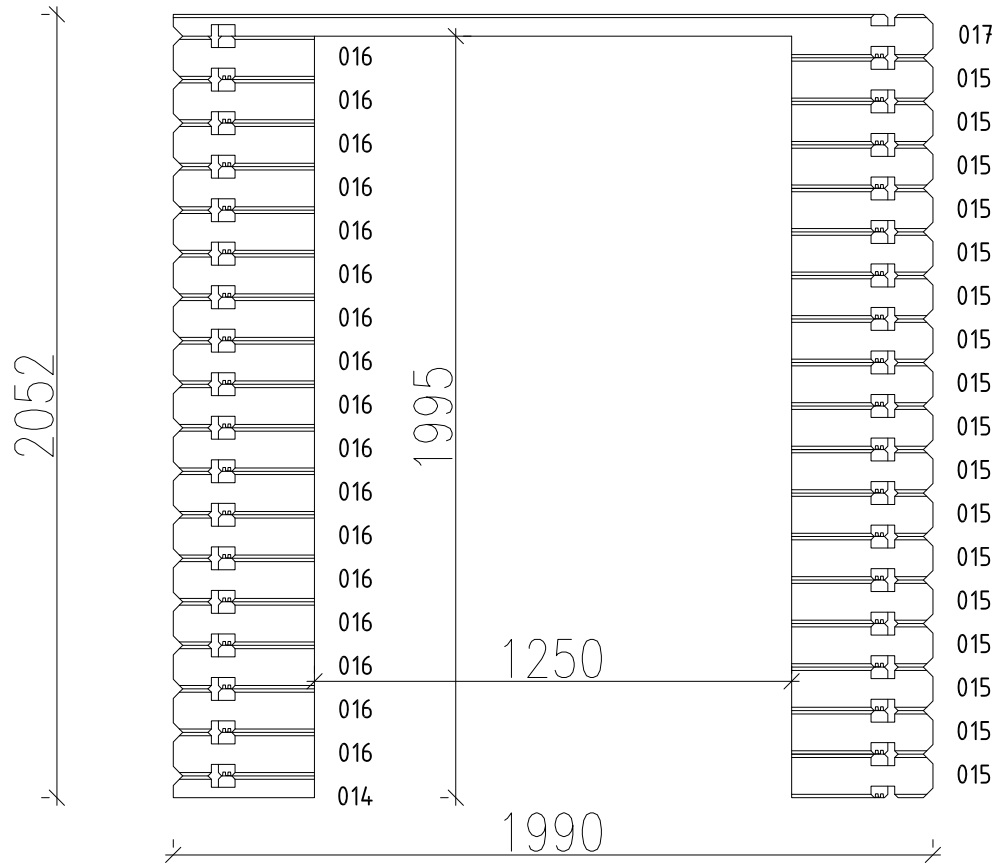

Wall 2

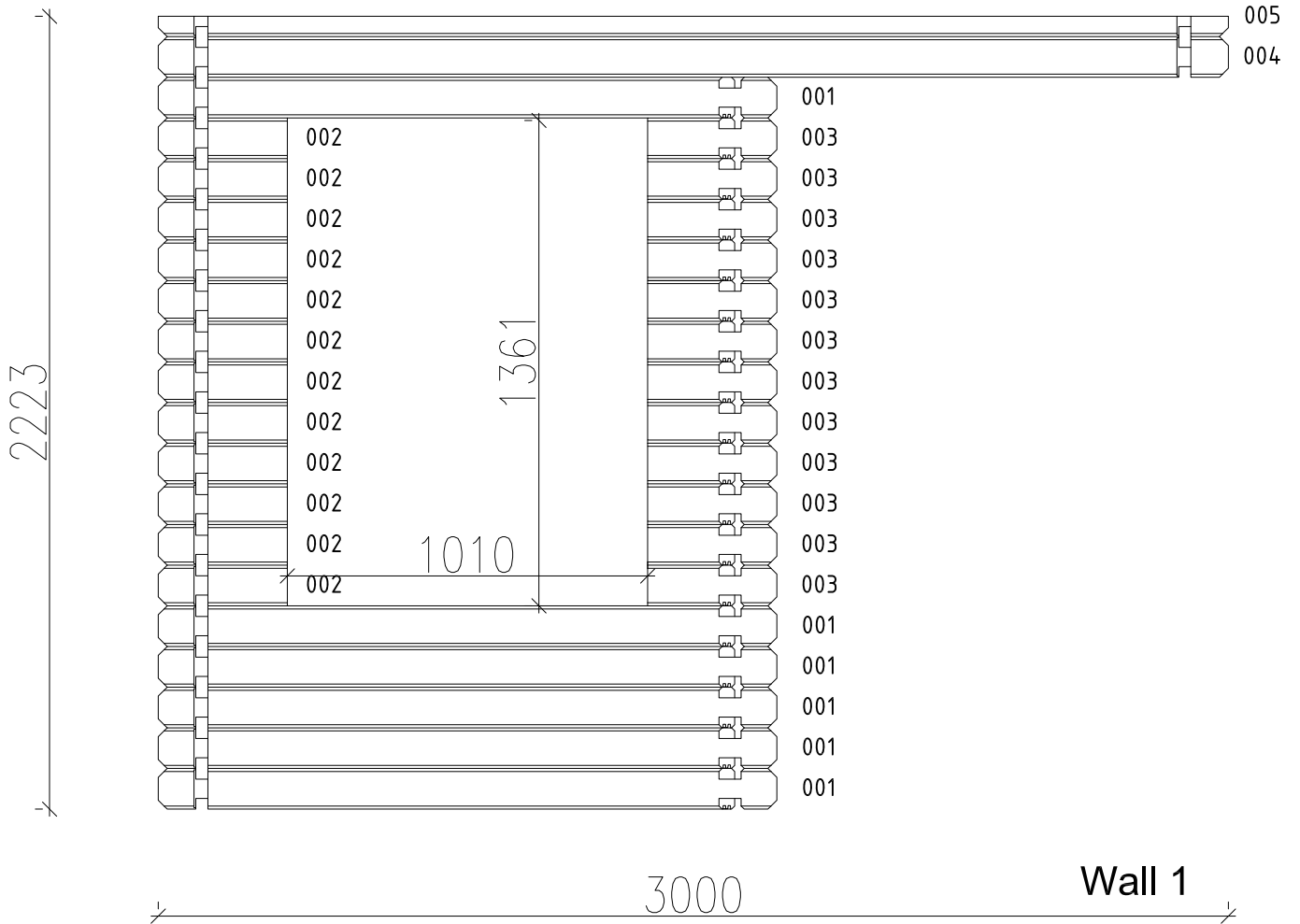

Wall 1

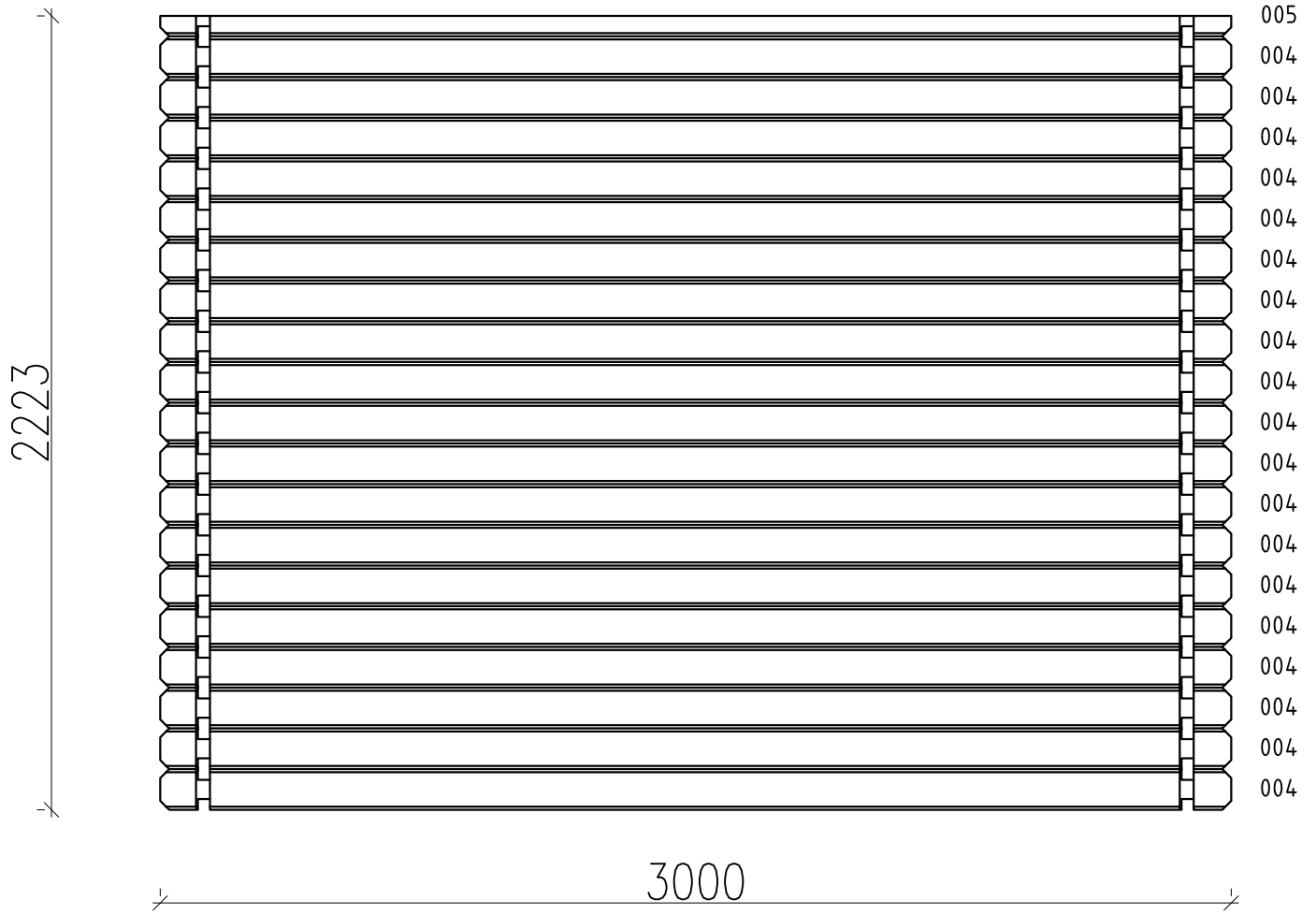

Wall 3

2223

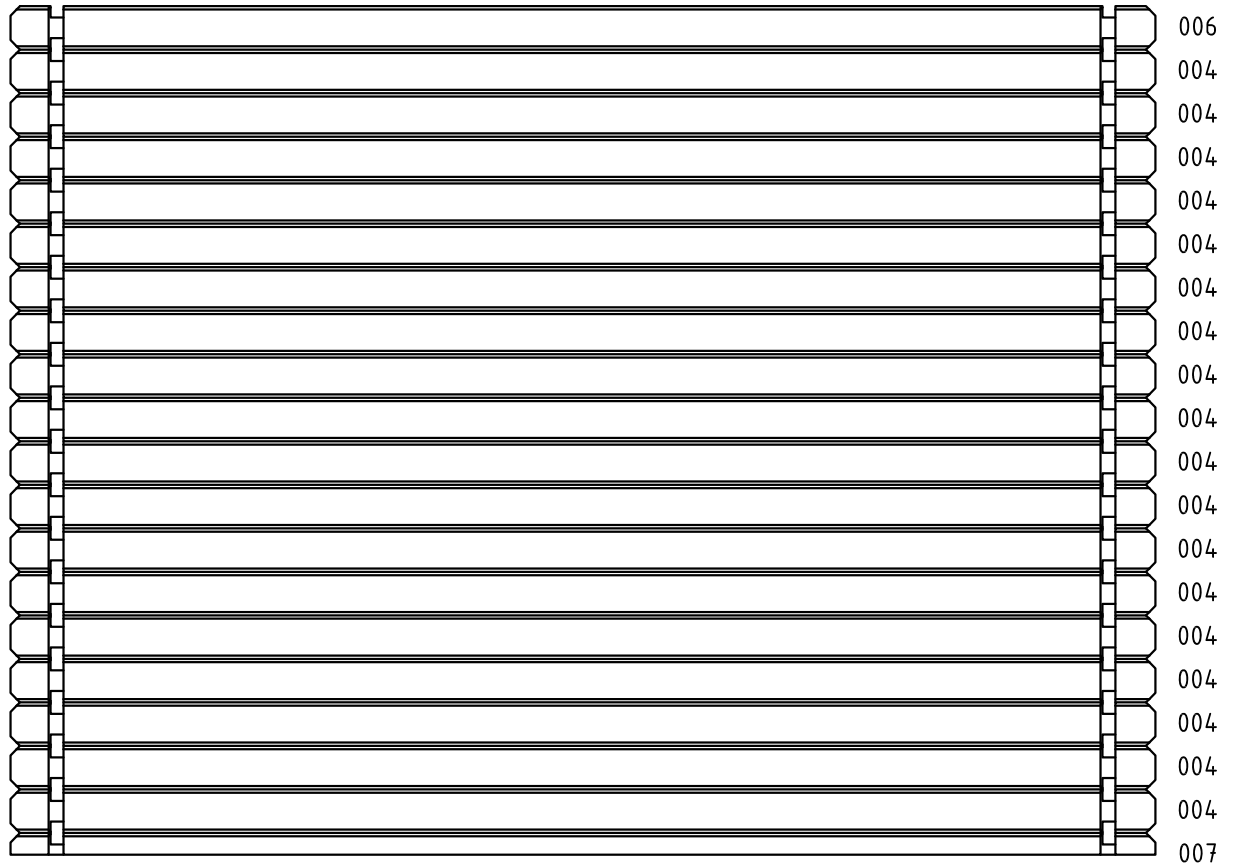

3000

Wall A

2223

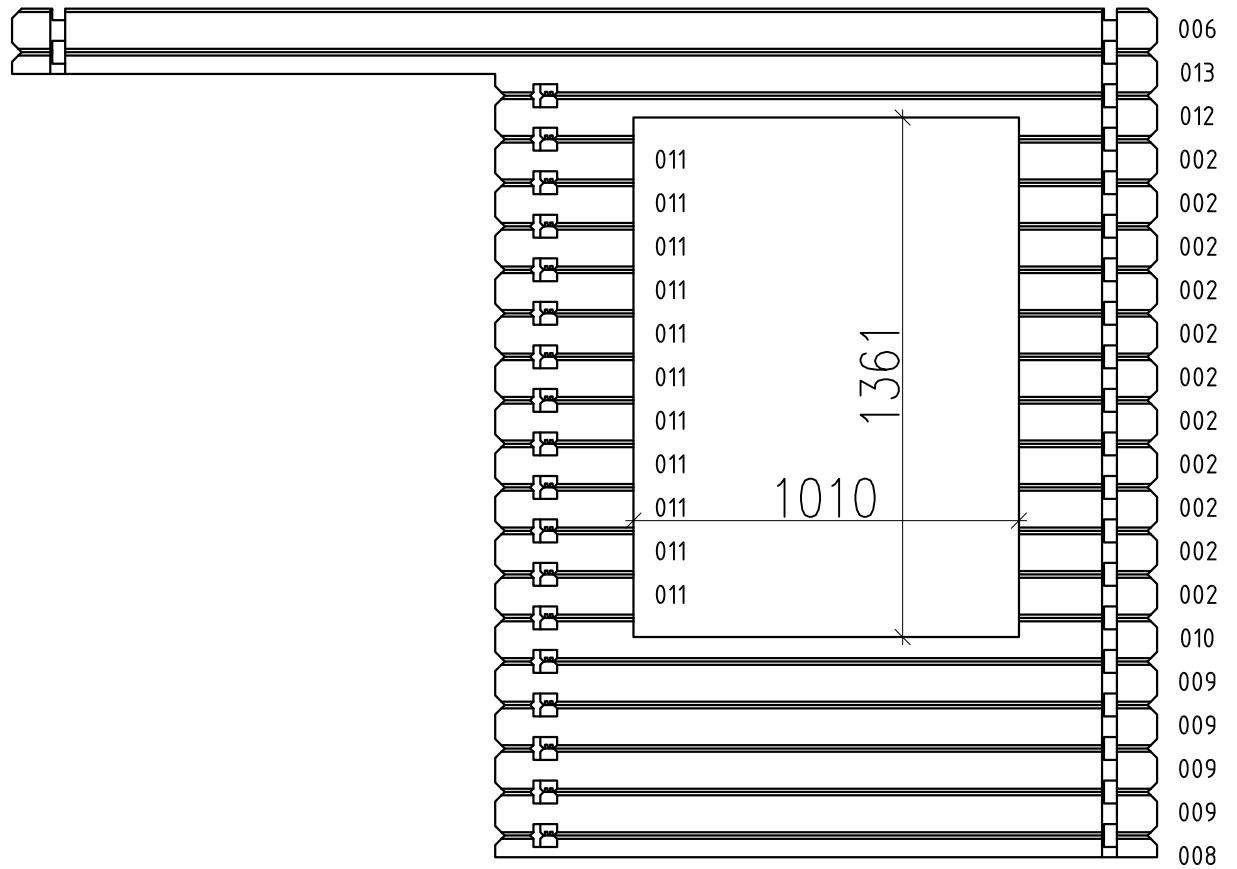

3000

Wall B

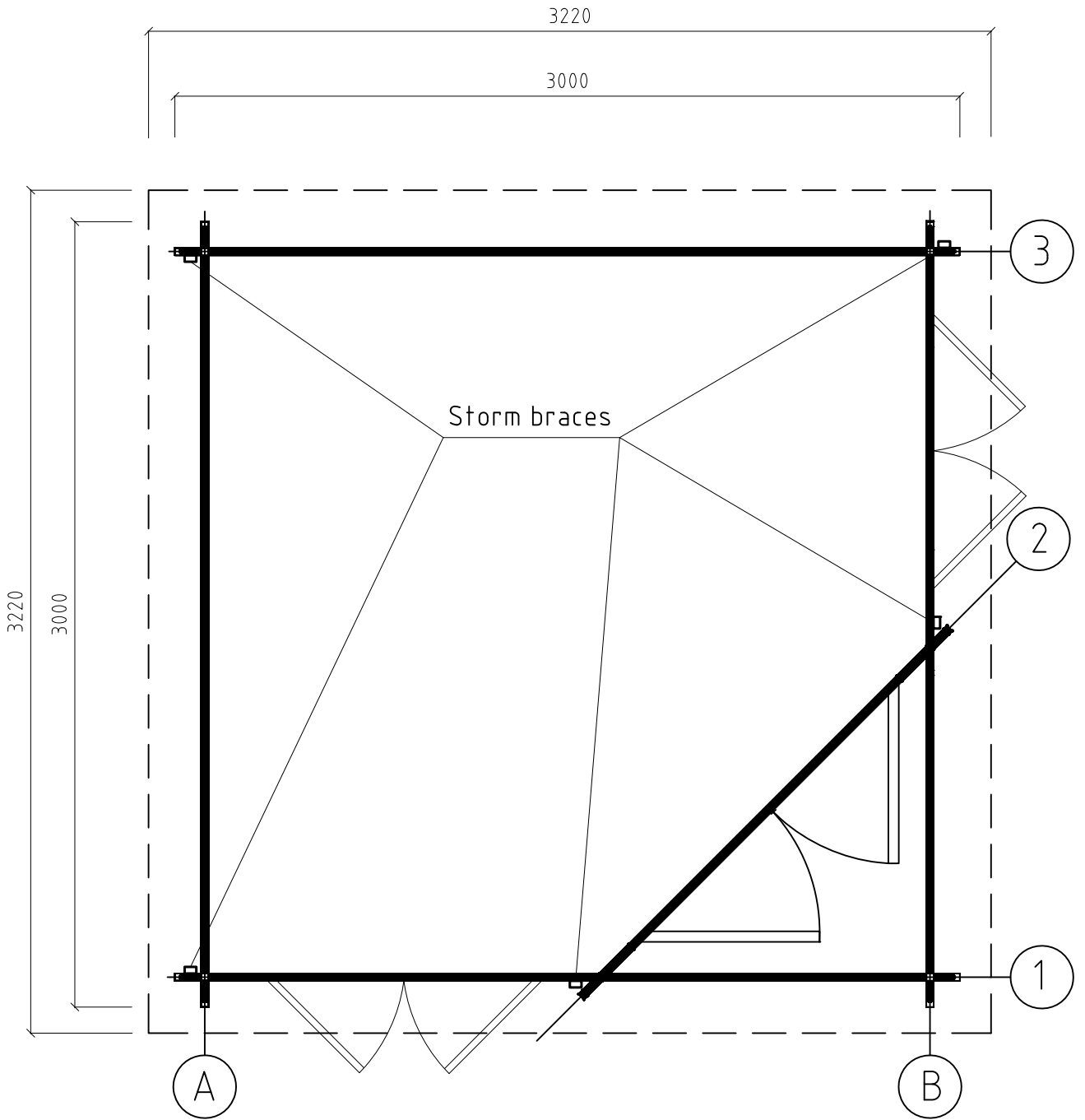

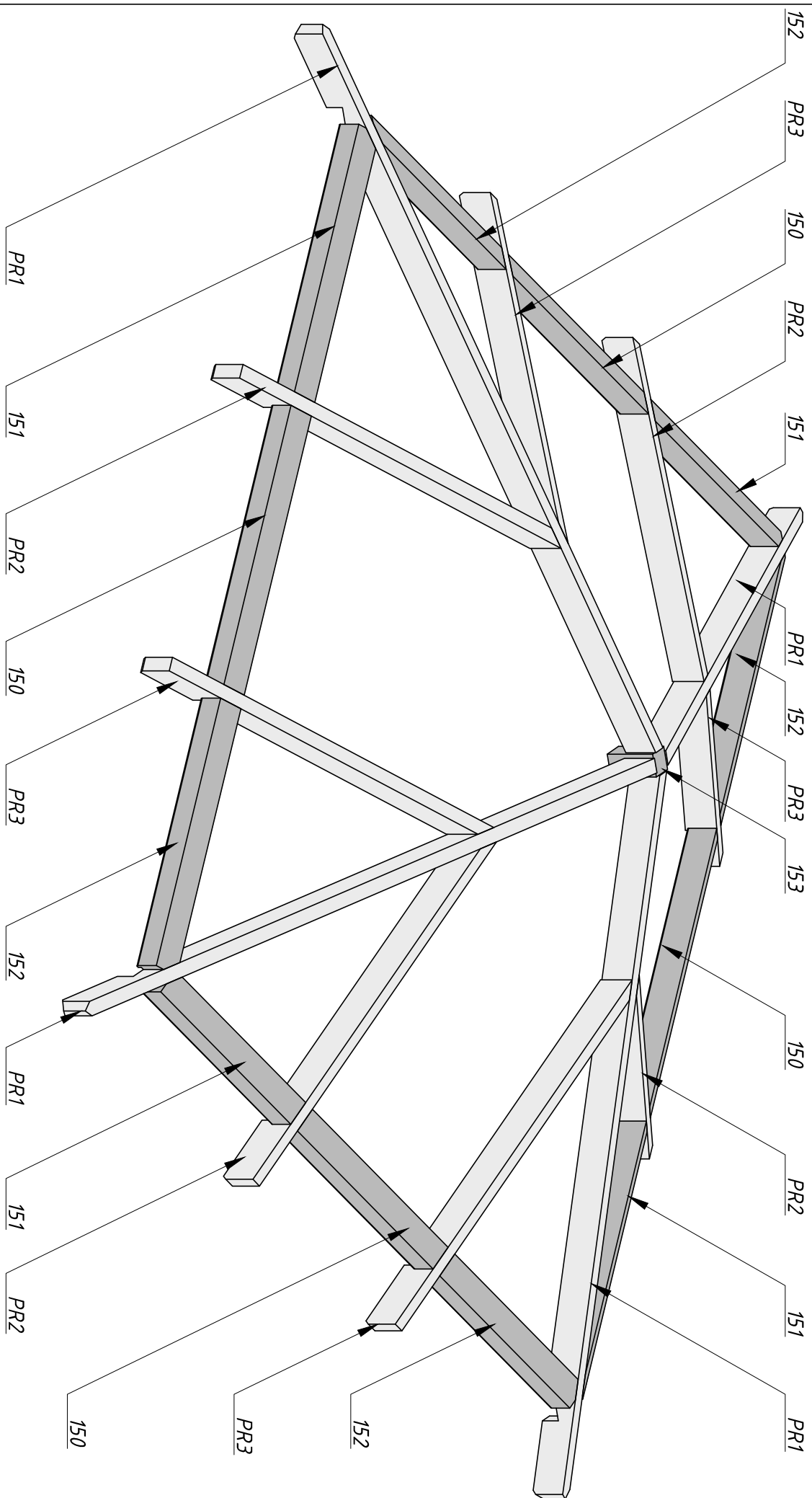

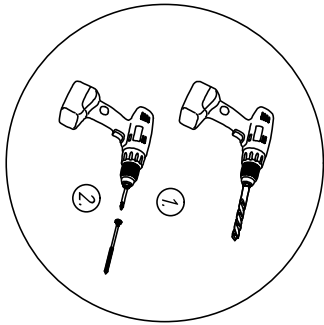
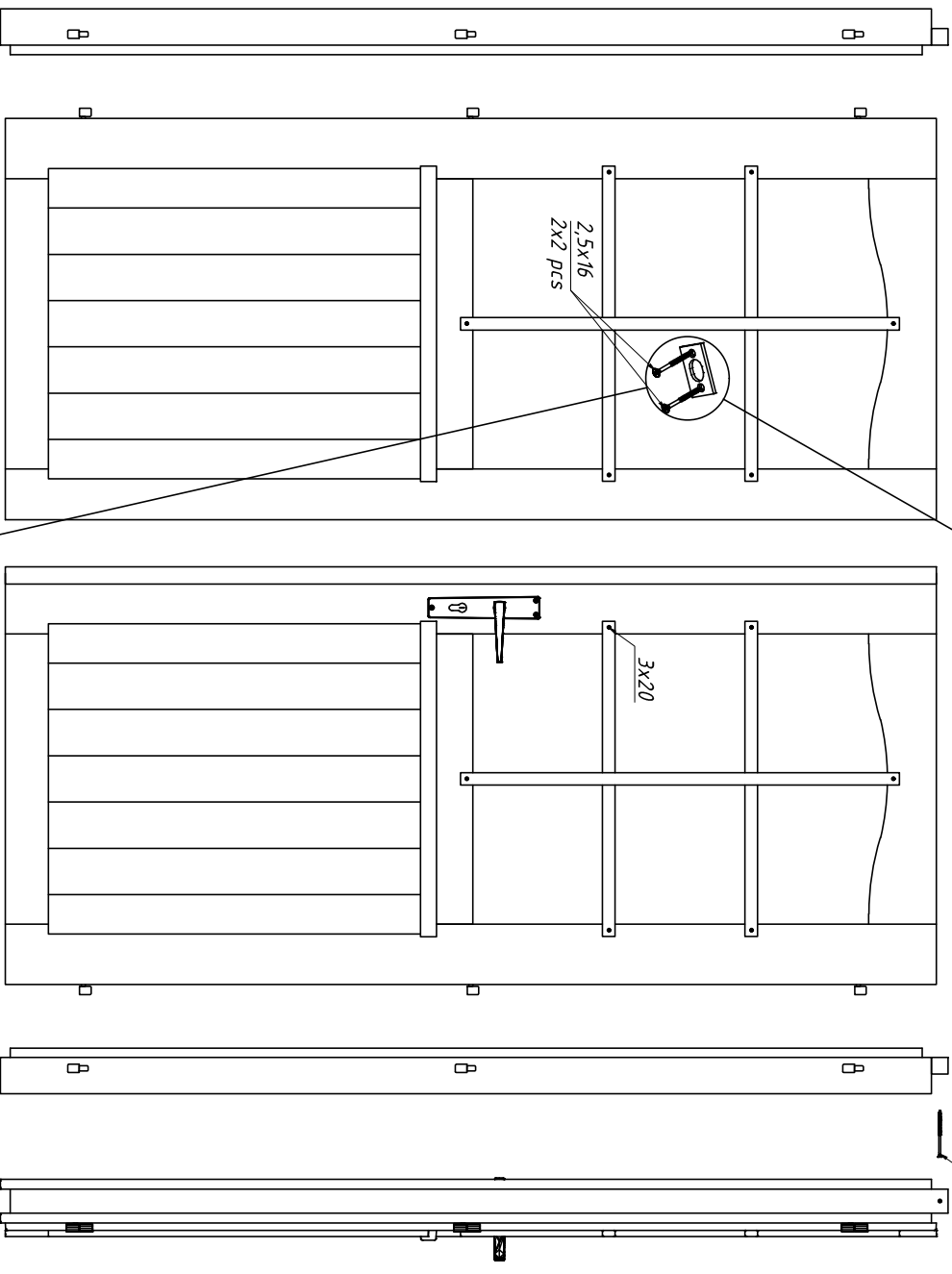
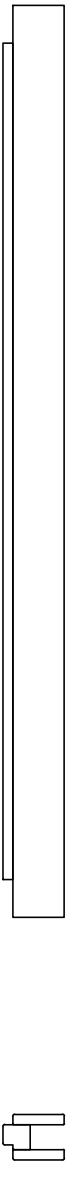
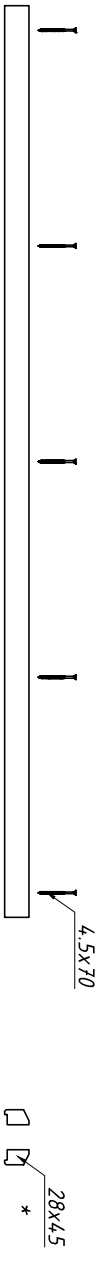

- * The specification may vary depending on the specific model.
- * Die Spezifikation können je nach Modell unterschiedlich sein.
- * Les spécifications peuvent varier selon le modèle spécifique.
- * Dependiendo del modelo, la especificación puede cambiar.
- * Le specifiche possono variare a seconda del modello.
- * Teknisset tiedot voivat vaihdella mallista riippuen.
- * Spezifikationen kan variera beroende på den specifika modellen.

